

SPINNER

TTS Triplex

Multi-Tasking Turning-Cell with 3 turrets

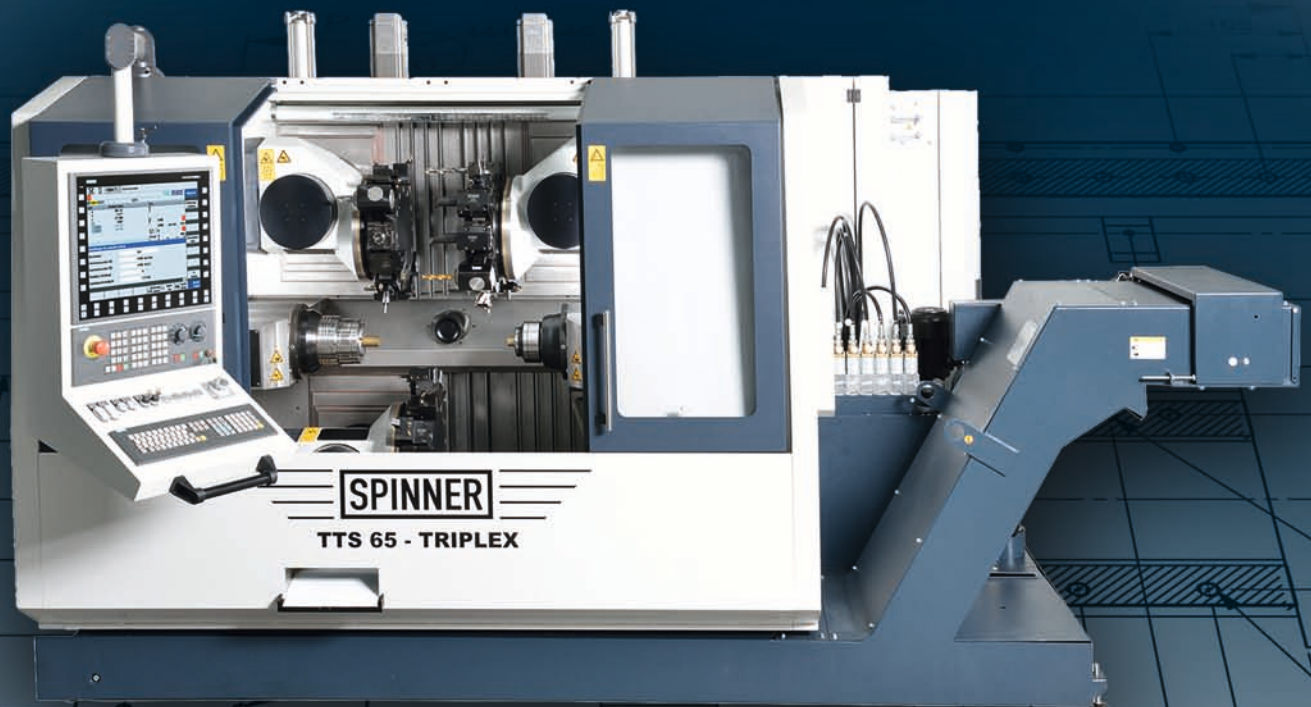

Mechanical Engineering

Made in Germany

www.spinner.eu.com
sales@spinner.eu.com

Machine Highlights

Latest control system from Siemens or Fanuc

The control panel can be mounted on the left or right side

Y axis in two turrets

Integrated cooling technology

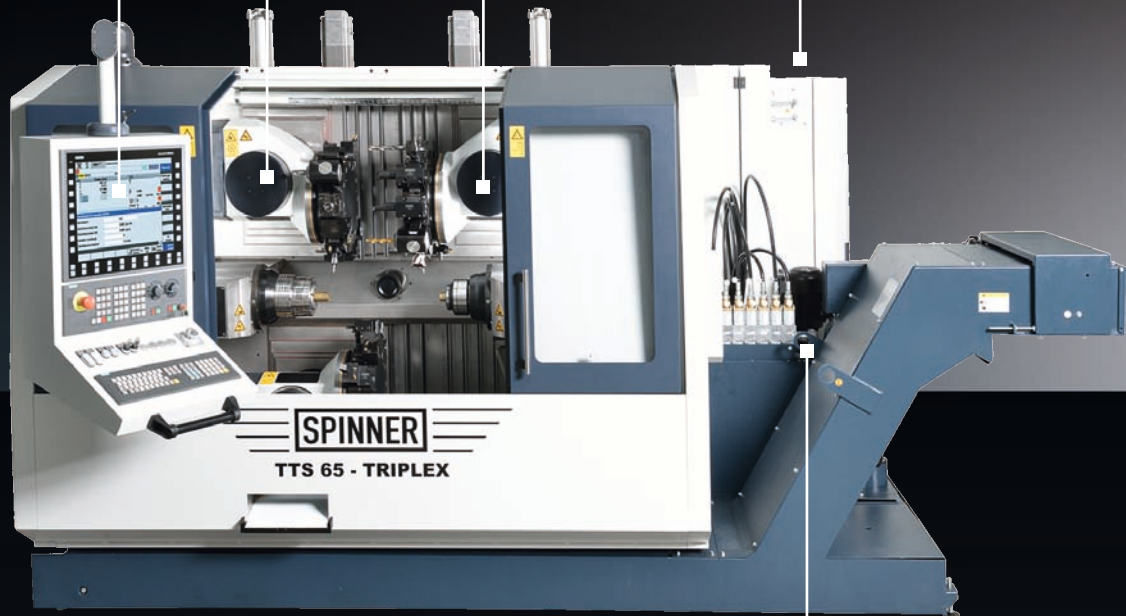

Machining of bars
or automation with robotic system



Powerful
Highly dynamic
Highly productive
Made in Germany

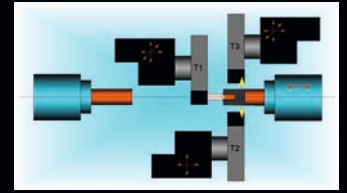
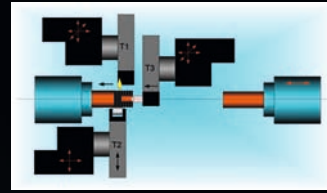

Powerful tool drive
on all 3 turrets

High speed SPINNER
servo turrets with tool
holders according to
BMT45 or VDI25

Each turret can be used on
both spindles for optimal
capacity utilisation and
shortest machining time

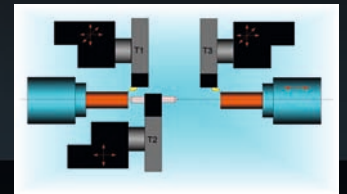
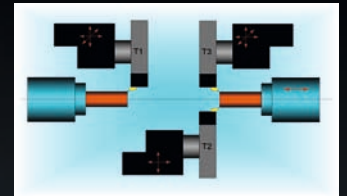
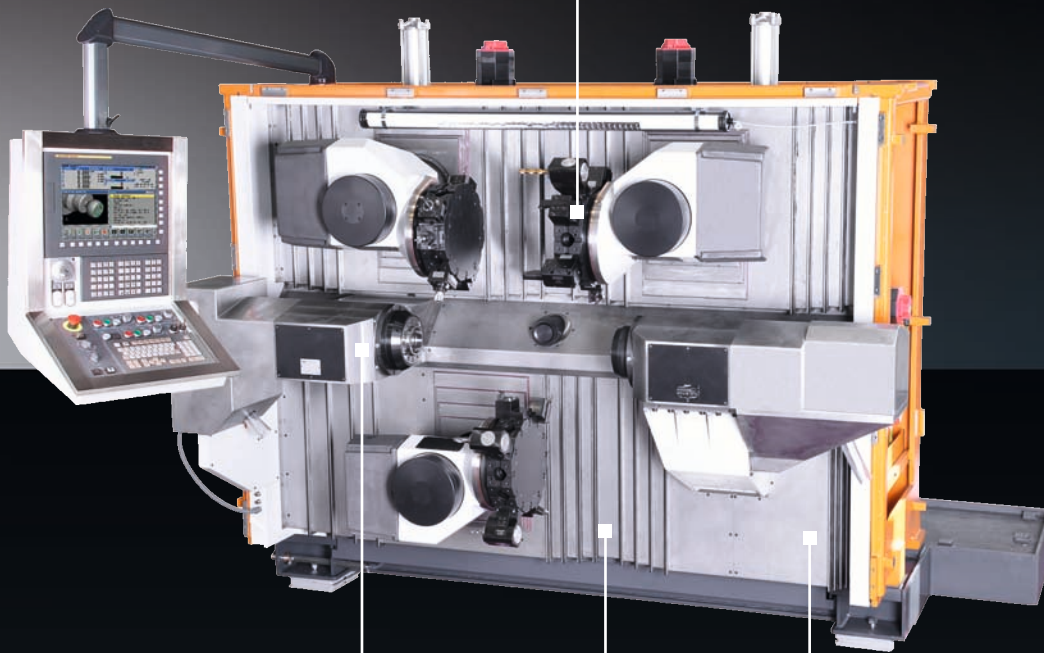

Spindles with 42 mm
or 65 mm bores

90 degrees slant bed for
free chip fall

Optimal working area guarding

Clearly structured working area with 3 (Triplex) turrets

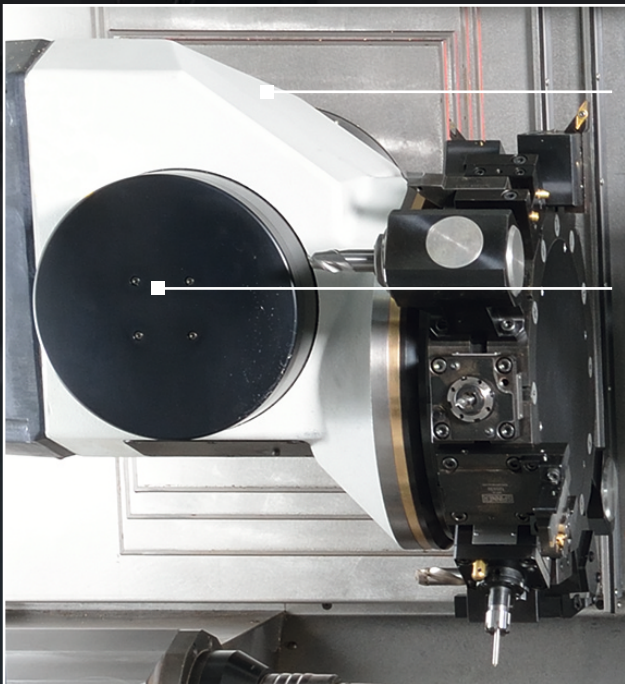
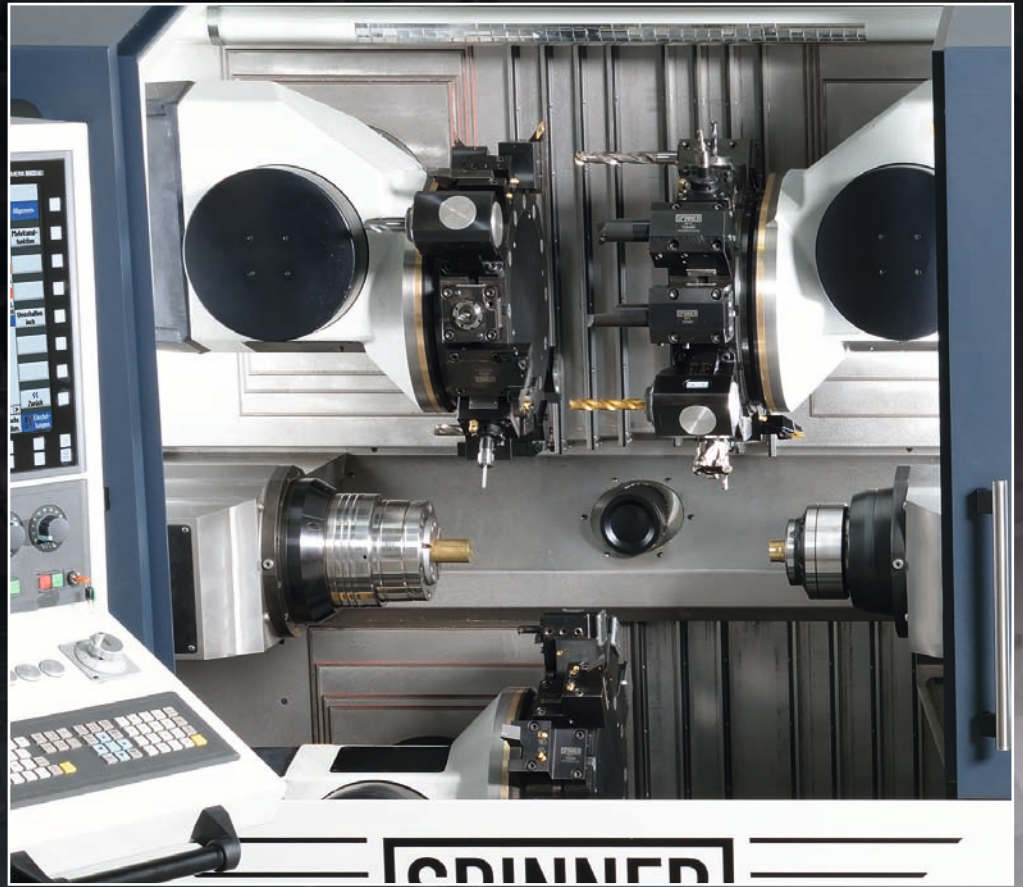

- **Optimised turrets**
with high stiffness and favourable interference contour
- **Integrated vibration absorber**
to reduce micro vibrations for higher metal cutting performance and improved surface quality
- **High thermal stability**
by direct measuring system and central cooling technology

• Tool holder BMT45 as standard

Your advantages at one glance when using BMT45 tool holders

- High toolholder exchange precision
- No adjustment is required
- High stiffness
- Higher turning and milling performance

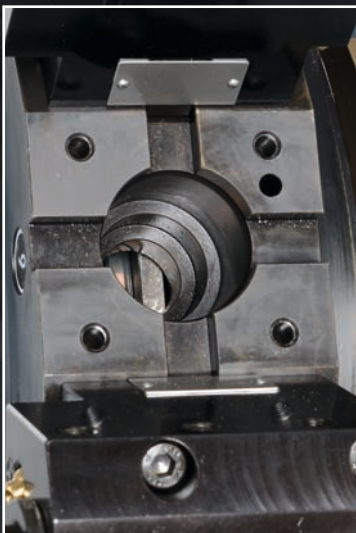
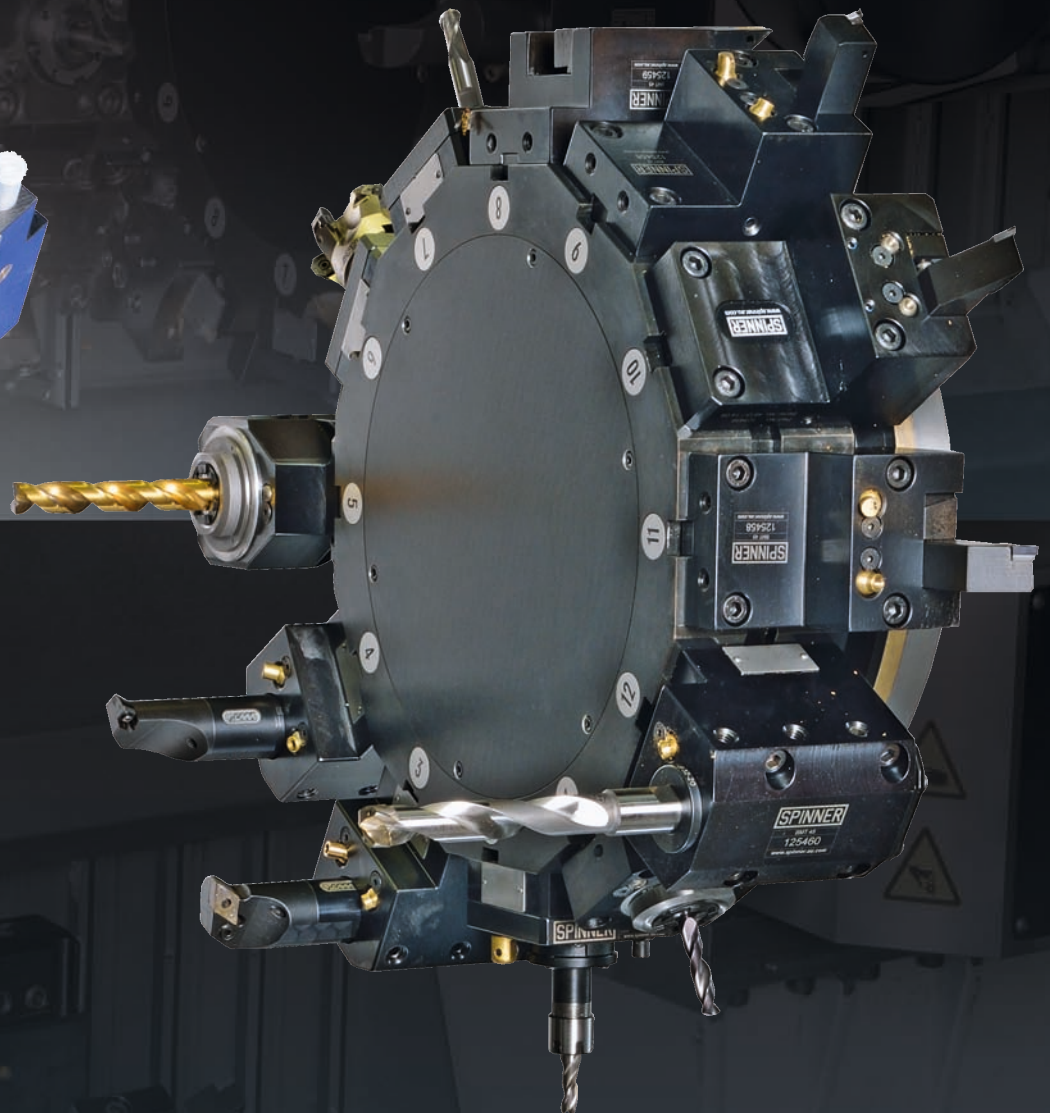

Tool holder VDI25 as option

Automation solutions

Fully automated production solutions for large-scale production
FROM A SINGLE SOURCE from SPINNER and SPINNER-
Automation



Your advantages at one glance

- Increase in productivity
- Cost reduction
- Optimal processes for your machining requirements
- Everything from one source

Ask us for your solution!

Bar feeding system



SPINNER SERVO short bar feeder for feeding bars up to a maximum of 1500mm

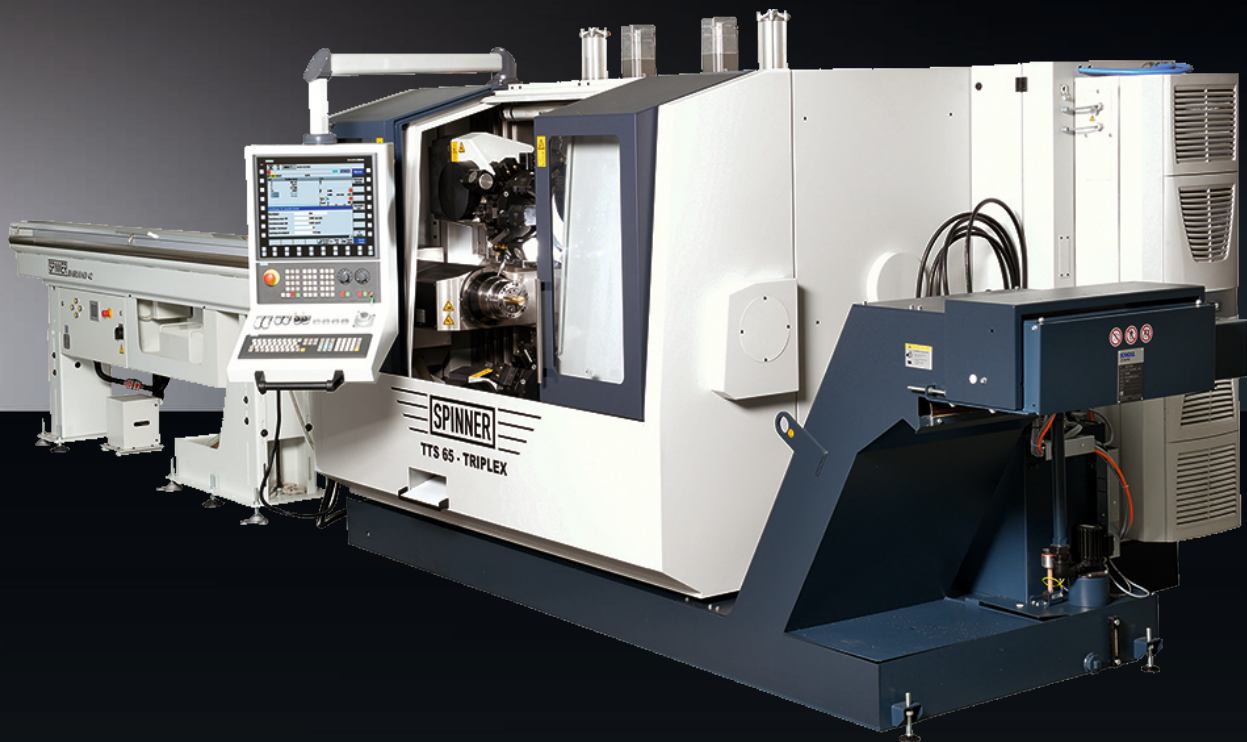

SPINNER SERVO bar loading magazine for feeding bars up to a maximum length of 3,2 metres



Working area	TTS 42	TTS 65
X1/X3 axis	180 mm	180 mm
X2 axis	180 mm	180 mm
Y1/Y3 axis	±45 mm	±45 mm
Z1/Z3 axis	704 mm	704 mm
Z2 axis	620 mm	620 mm
Axes		
Rapide traverse X, Y, Z	30 m/min	30 m/min
Spindle 1		
Max. spindle speed	7.000 rpm	5.000 rpm
Spindle nose	ø110 mm	DIN A6
Spindle bore	42 mm	65 mm
Power chuck	140 mm	210 mm
Performance	22 kW (S6 40%)	24 kW (S3 40%)
Torque	128 Nm (S6 40%)	151 Nm (S3 40%)
Spindle 2		
Max. spindle speed	7.000 rpm	7.000 rpm
Spindle nose	ø110 mm	ø110 mm
Spindle bore	42 mm	42 mm
Power chuck	140 mm	140 mm
Performance	22 kW (S6 40%)	22 kW (S6 40%)
Torque	128 Nm (S6 40%)	128 Nm (S6 40%)
Turret		
Number of tool stations	3x12	3x12
Number of driven tools	3x12	3x12
Toolholder	Standard BMT45 / Option VDI25	Standard BMT45 / Option VDI25
Max. speed of driven tools	Up to 8.000 rpm	Up to 8.000 rpm
Performance ¹⁾	4,3 kW (S3 25%)	4,3 kW (S3 25%)
Torque ¹⁾	13,6 Nm (S3 25%)	13,6 Nm (S3 25%)
General indications		
Dimensions (L x W x H) ²⁾	2880 x 2130 x 1990 mm	2880 x 2130 x 1990 mm
Weight ³⁾	~7.500 kg	~7.700 kg

1) Valid for rated speed 3.000 rpm

2) See floorplan

3) Machine net weight

Main Spindle TTS42
Sub Spindle TTS42/TTS65

7.000 rpm

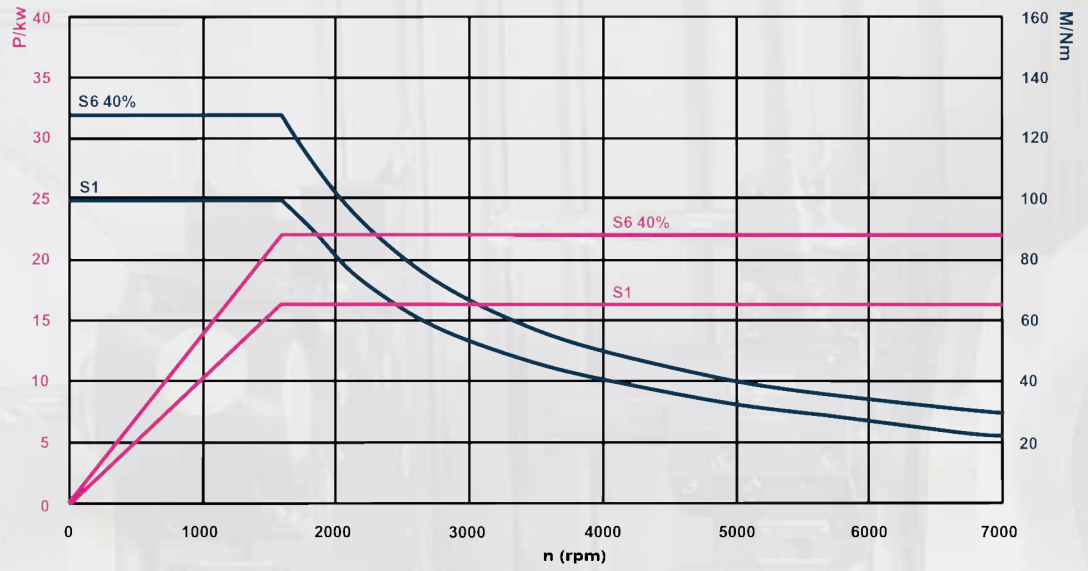

Main Spindle TTS65

5.000 rpm

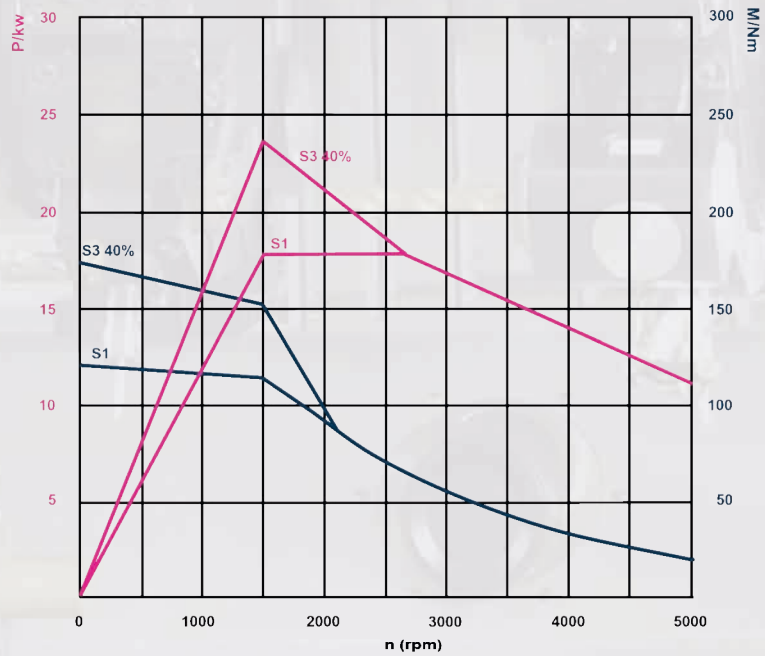

Driven tool

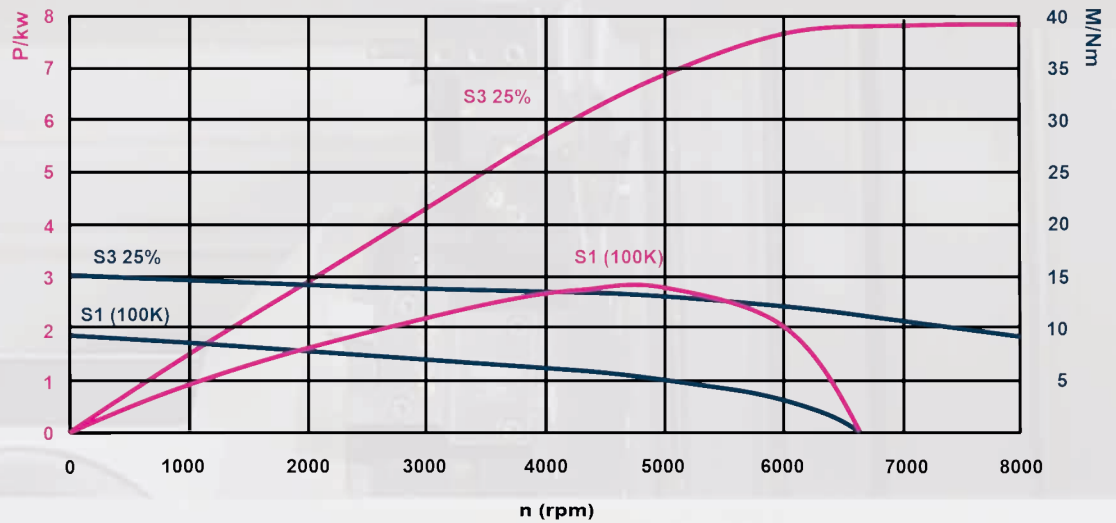

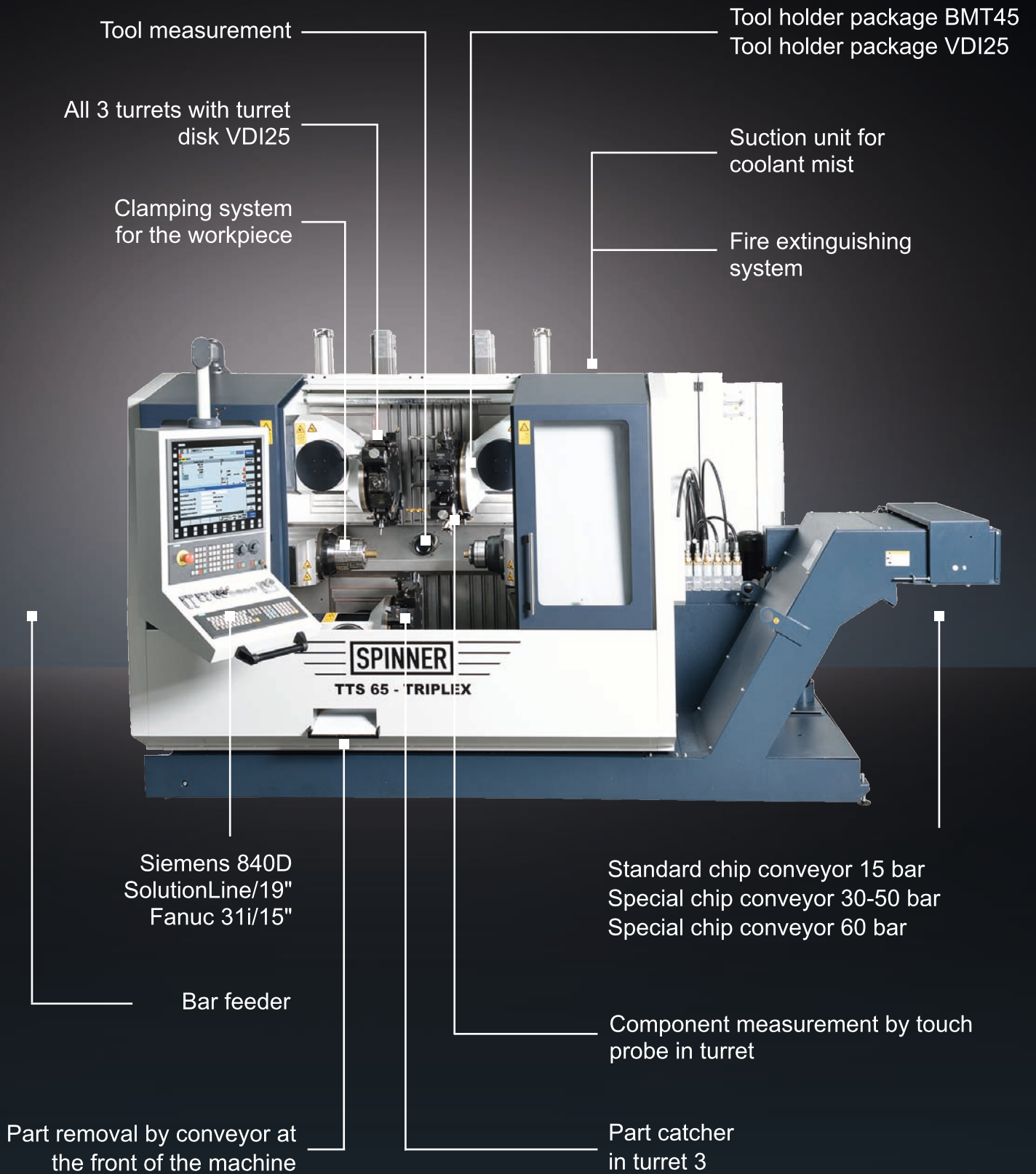

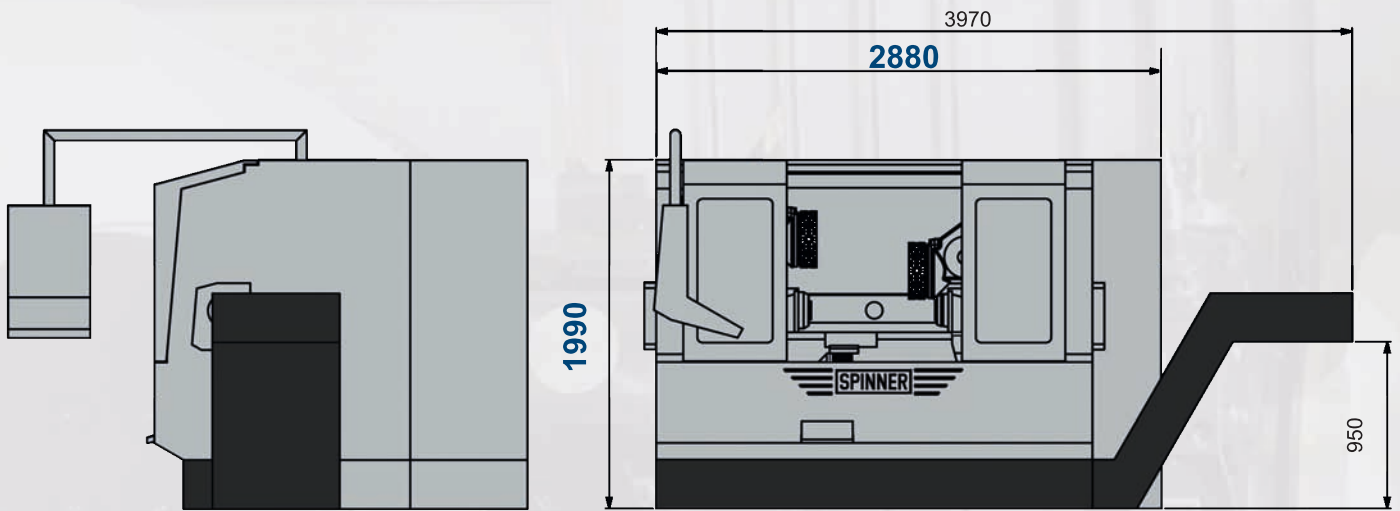

■ Version with standard chip conveyor

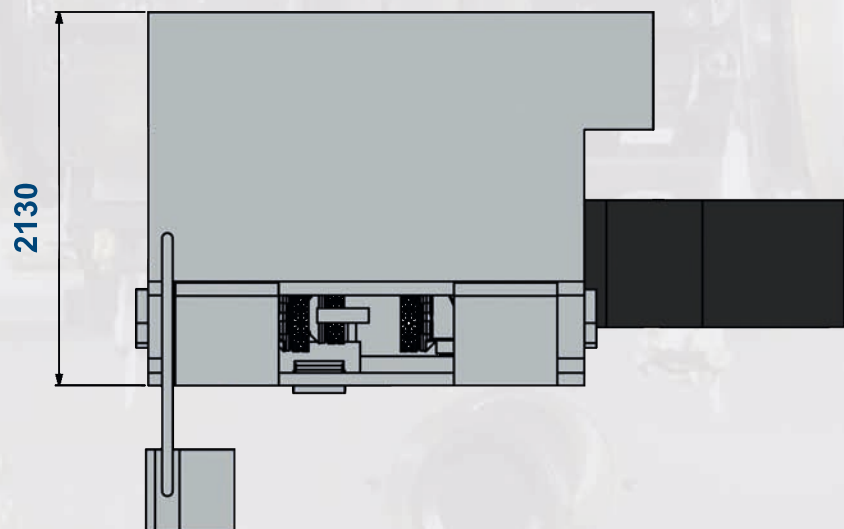

SPINNER

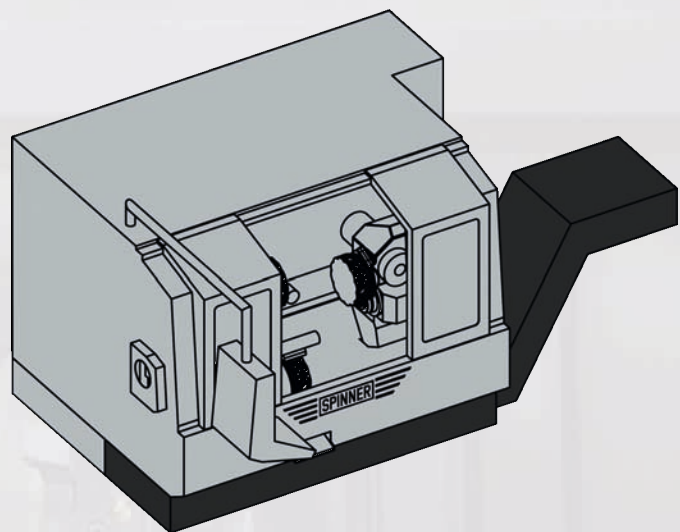



Werkzeugmaschinenfabrik GmbH



Spinner Machine-Tools are working successfully world wide with many well known clients in more than 60 countries on 6 continents. We have been fortunate enough to attract small component suppliers in addition to well known global groups in all metal machining industries.

We have designed and produced the most modern machine-tools since 1950. More than 20.000 delivered machines demonstrate their high efficiency, precision and reliability, everyday.

Although Spinner is a medium-sized enterprise we produce and sell more than 1.000 CNC machines a year. And the number is increasing every year. Our company combines the know-how of a global player with the flexibility and cost-effective structures of a family owned business.

Place your trust in our products as well and let us know what we can do for you.



Video

SPINNER Werkzeugmaschinenfabrik GmbH

Rudolf-Diesel-Ring 24

82054 Sauerlach

Tel. +49 (0) 8104 803-0

Fax +49 (0) 8104 803-19

sales@spinner.eu.com



Stand 10.6.2017

Technical changes of specifications and pictures are subject to change without notice - Pictures can include options, accessories